

EDISP (LTIlect)
(English) Digital Signal Processing
DT systems, LTI

November 19, 2014

A DT system: an operator mapping an input sequence $x[n]$ into an output sequence $y[n]$.

$$y[n] = T\{x[n]\}$$

→ A rule (formula) for computing $y(n)$ from $x(n)$

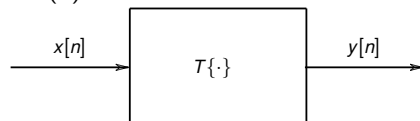

Implementations:

- PC program
- matlab m-file
- custom VLSI or FPGA
- programmable digital signal processor

Examples:

$$y(n) = 3 \cdot x(n)$$

$$y(n) = \frac{x(n) + x(n-1)}{2}$$

$$y(n) = \frac{1}{M} \sum_{k=0}^{M-1} x(n-k)$$

$$y(n) = \sum_{k=-\infty}^{\infty} h(k) \cdot x(n-k)$$

$$y(n) = x(n)^2$$

Linearity property

$$T\{\alpha_1 x_1[n] + \alpha_2 x_2[n]\} = \alpha_1 T\{x_1[n]\} + \alpha_2 T\{x_2[n]\}$$

in other words:

if

$$x_1[n] \longrightarrow y_1[n]$$

$$x_2[n] \longrightarrow y_2[n]$$

then

$$\alpha x_1[n] \longrightarrow \alpha y_1[n] \quad (\text{scaling, homogeneity})$$

$$x_1[n] + x_2[n] \longrightarrow y_1[n] + y_2[n] \quad (\text{additivity})$$

Time invariance (shift invariance)

If

$$T\{x[n]\} = y[n]$$

then

$$\forall n_0, T\{x[n - n_0]\} = y[n - n_0]$$

Shift does not modify result \leftrightarrow System properties do not change

- $y(n) = 3 \cdot x(n)$ – is linear; it is also *memoryless*
- $y(n) = \frac{x(n)+x(n-1)}{2}$ (not memoryless):

$$\begin{aligned} T\{\alpha_1 x_1(n) + \alpha_2 x_2(n)\} &= \frac{[\alpha_1 x_1(n) + \alpha_2 x_2(n)] + [\alpha_1 x_1(n-1) + \alpha_2 x_2(n-1)]}{2} = \\ &= \frac{\alpha_1 x_1(n) + \alpha_1 x_1(n-1)}{2} + \frac{\alpha_2 x_2(n) + \alpha_2 x_2(n-1)}{2} = \\ &= \alpha_1 \frac{x_1(n) + x_1(n-1)}{2} + \alpha_2 \frac{x_2(n) + x_2(n-1)}{2} = \\ &= \alpha_1 y_1(n) + \alpha_2 y_2(n) \quad \text{cnd} \end{aligned}$$

not L $y(n) = (x(n))^2$ because

$$T\{x_1(n) + x_2(n)\} = (x_1(n) + x_2(n))^2 = (x_1(n))^2 + (x_2(n))^2 + [2 \cdot x_1(n)x_2(n)]$$

shift example

Input signals $x[n-k]$.

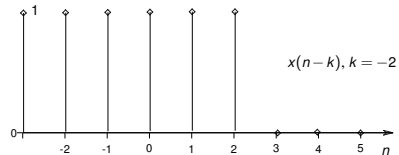
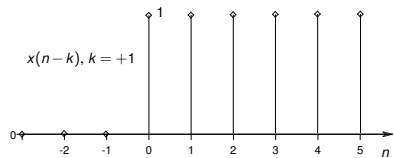
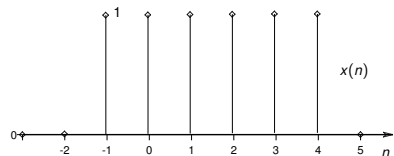

Responses $T\{x[n-k]\}$ of TI system $T\{.\}$

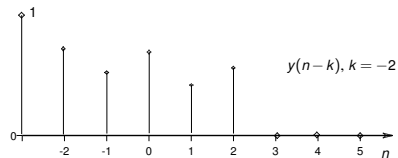
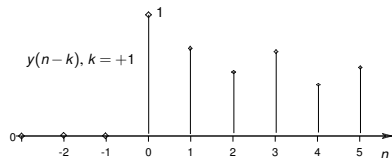
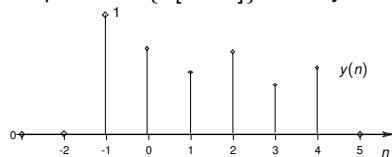

causality

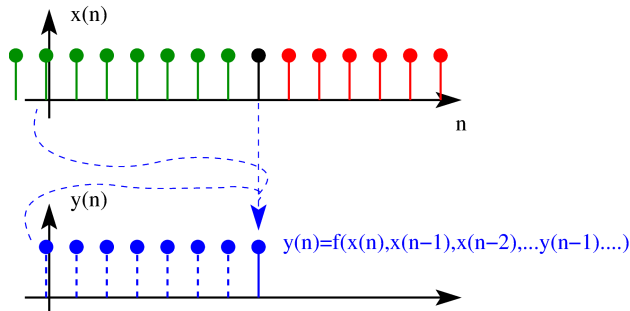

→ $y(n_0)$ depends only on $x(n)$, $n \leq n_0$ (important in real-time implementations, unimportant for off-line processing)

stability

→ bounded input causes bounded output [BIBO]

bounded → $\exists B_x : \forall n |x(n)| \leq B_x < \infty$

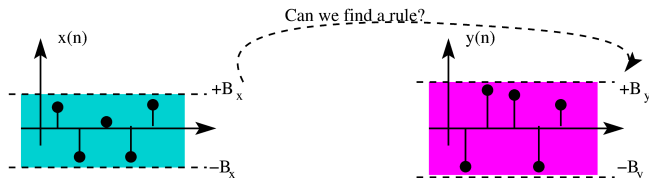

Decimator (compressor)

$$y(n) = x(Mn)$$

→ L, but not TI (*prove it!*)

1-st order difference

forward: $y(n) = x(n+1) - x(n)$ → noncausal

backward: $y(n) = x(n) - x(n-1)$ → causal

Accumulator

$$y(n) = \sum_{k=-\infty}^n x(k)$$

→ unstable; (*hint: feed it with $u[n]$*)

LTI systems: impulse response

$h[n] = T\{\delta[n]\} \longrightarrow$ impulse response of $T\{.\}$

$h[n]$ characterizes completely system $T\{.\}$ – we may compute its response for any input $x[n]$.

- Decompose $x[n]$ into weighted sum of impulses $\delta[n-k]$

$$x[n] = \sum_{k=-\infty}^{\infty} x[k]\delta[n-k]$$

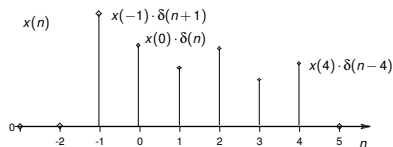

- Superpose responses (use LTI properties)

$$y[n] = \sum_{k=-\infty}^{\infty} x[k]h[n-k]$$

\longrightarrow this is a **convolution sum**

Convolution example

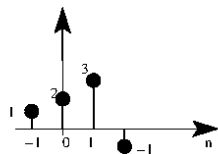

*

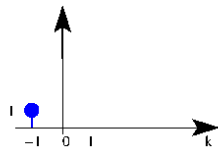
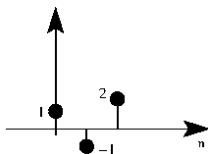

$k=-1$

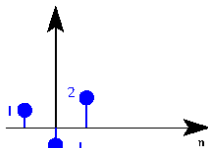

1
2
3
-1

1	-1	2
---	----	---

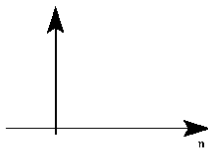

Convolution example

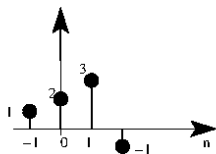

*

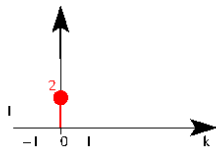
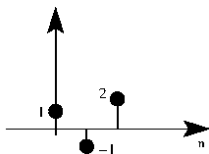

$k=0$

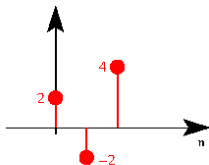

2 -2 4

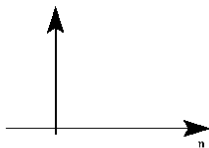

Convolution example

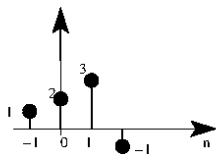

*

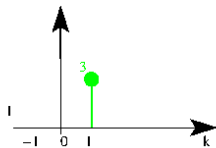
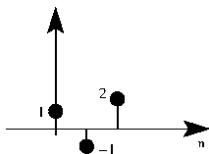

$k=1$

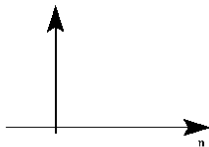
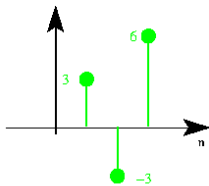

Convolution example

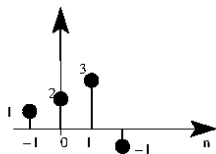

*

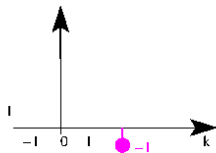
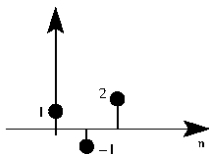

$k=2$

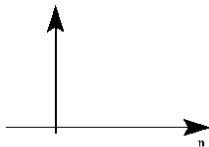
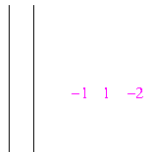
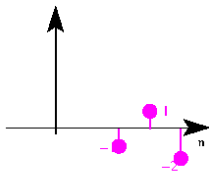

Convolution example

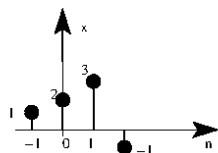

*

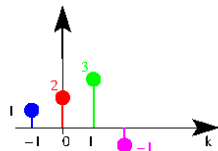
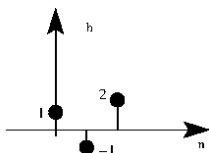

$k=-1$

$k=0$

$k=1$

$k=2$

$x(k)h(n-k)$

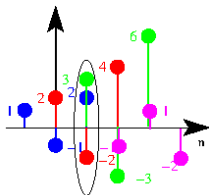

1	1	-1	2			
2		2	-2	4		
3			3	-3	6	
-1					-1	1
						-2
	1	1	3	0	7	-2

$y(n)=x(n)*h(n)$

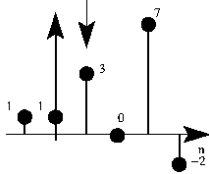

$$y[n] = \sum_{k=-\infty}^{\infty} x[k]h[n-k]$$

we denote as

$$y[n] = x[n] * h[n]$$

Properties of “*”

“*” is commutative: $x[n] * h[n] = h[n] * x[n]$

“*” distributes over addition $x[n] * (h_1[n] + h_2[n]) = x[n] * h_1[n] + x[n] * (h_2[n])$

→ Convolution of a signal $x[n]$ with given fixed $h[n]$ is linear!

System and $h[n]$

- causality $\Leftrightarrow h[n] = 0, n < 0$. A hint: $y(n) = \sum_{k=-\infty}^{\infty} h(k)x(n-k)$
- stability $\Leftrightarrow S = \sum_{k=-\infty}^{\infty} |h(k)| < \infty$

Linear difference equations

... describe an important class of LTI systems.

$$\sum_{k=0}^N a_k y(n-k) = \sum_{k=0}^M b_k x(n-k), \quad a_0 = 1 \text{ (traditionally)}$$

or

$$\begin{aligned} y(n) &= -a_1 \cdot y(n-1) - a_2 \cdot y(n-2) - \dots - a_n \cdot y(n-N) + \\ &+ b_0 \cdot x(n) + b_1 \cdot x(n-1) + b_2 \cdot x(n-2) + \dots + b_n \cdot x(n-M) \end{aligned}$$

Note: if, for a given input $x_p[n]$, an output sequence $y_p[n]$ satisfies given difference equation,

$$y[n] = y_p[n] + y_h[n]$$

will also satisfy the equation, if $y_h[n]$ is a solution to $\sum_{k=0}^N a_k y(n-k) = 0$ (homogenous equation).

Difference equation – example

An equation: $y(n) = a \cdot y(n-1) + x(n)$

with input

$$x(n) = 0, n < 0$$

$$x(n) \neq 0, n > 0.$$

$$y(0) = a \cdot y(-1) + x(0)$$

$$y(1) = a \cdot y(0) + x(1)$$

$$y(2) = a \cdot y(1) + x(2)$$

...

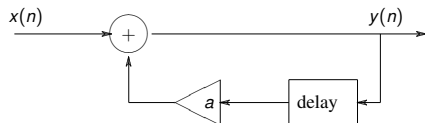

Initial condition: $y(-1) = \alpha$

Let $x[n] = \delta[n]$

$$y(0) = a \cdot \alpha + 1$$

$$y(1) = a(a \cdot \alpha + 1) = a^2 \alpha + a$$

$$y(2) = a^3 \alpha + a^2$$

...

$$y(n) = a^{n+1} \alpha + a^n$$

Difference equation – impulse response (example continued)

$$y(n] = a \cdot y[n-1] + x[n]$$

Initial condition: $y[-1] = \alpha$

$$x[n] = \delta[n]$$

Solution: $y[n] = a^{n+1} \alpha + a^n$

Find a homogenous part!

Stability:

$$1 < a: a^n \rightarrow \infty$$

$$0 < a < 1: a^n \rightarrow 0$$

$$-1 < a < 0: a^n \rightarrow 0$$

$$a < -1: a^n \rightarrow ???$$

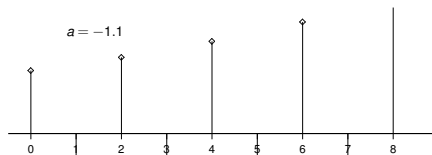
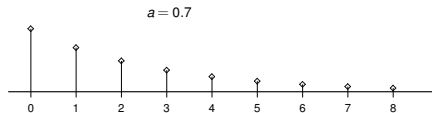
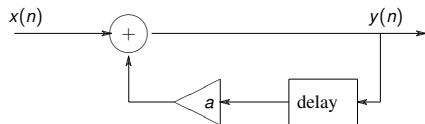

Z-transform – what and why

- DTFT – a transform based on periodic decomposition (basis: $e^{jn\theta}$ sequences)
- responses of most LTI systems – made of short sequences (FIR) and decaying complex exponentials $r^n e^{jn\theta}$ (IIR)
- $r^n e^{jn\theta} = (re^{j\theta})^n = z^n$ can be a good basis

Z-transform is a tool for analyzing transient signals, such as an impulse response of a system.

Z-transform definition

\mathcal{Z} – a generalization of DTFT, similar to \mathcal{L} as a generalization of CTFT

$$X(z) = \sum_{n=-\infty}^{\infty} x(n)z^{-n}$$

→ DTFT is equal to $X(z)$ at unit circle $z = e^{j\theta}$

Convergence: same as for DTFT of $x[n] \cdot r^{-n}$ (substitute $z = r \cdot e^{j\theta}$)

$$\sum_{n=-\infty}^{\infty} |x(n)r^{-n}| < \infty$$

example: $u[n]$ is not absolutely summable; $u(n) \cdot r^{-n}$ can be, if $|r^{-1}| < 1$

→ $\mathcal{Z}(u[n])$ is convergent for $r > 1$.

Properties:

- Linearity (*each student will recite the formula at 4 a.m.*),
- shift $x(n - n_0) \xleftrightarrow{Z} z^{-n_0} \cdot X(z)$,
- multiplication $z_0^n \cdot x(n) \xleftrightarrow{Z} X(z/z_0)$,
- transform differentiation $nx(n) \xleftrightarrow{Z} -z dX(z)/dz$,
- conjugation $x^*(n) \xleftrightarrow{Z} X^*(z^*)$,
- time reversal $x(-n) \xleftrightarrow{Z} X(1/z)$,
- initial value $x(0) = \lim_{z \rightarrow \infty} X(z)$ if $x(n) = 0$ for $n < 0$ (*hint: limit of each term ...*)
- multiplication $x_1(n) \cdot x_2(n) \xleftrightarrow{Z} 1/(2\pi j) \oint_C X_1(v) X_2(z/v) v^{-1} dv$ **complex!**
convolution

What happens to ROC with above transformations?

Examples

- $x(n) = a^n u(n)$ (causal)

$$X(z) = \sum_{n=-\infty}^{\infty} a^n u(n) z^{-n} = \sum_{n=0}^{\infty} (az^{-1})^n = \frac{1}{1 - az^{-1}} = \frac{z}{z - a}, \quad |z| > |a|$$

- $x(n) = -a^n u(-n-1)$ (non-causal)

$$X(z) = - \sum_{n=-\infty}^{-1} (az^{-1})^n = 1 - \sum_{n=0}^{\infty} (a^{-1}z)^n = \frac{1}{1 - az^{-1}} = \frac{z}{z - a}, \quad |z| < |a|$$

- $x(n) = \begin{cases} a^n & n = 0, 1, \dots, N-1 \\ 0 & \text{otherwise} \end{cases}$ (finite)

$$X(z) = \sum_{n=0}^{N-1} a^n z^{-n} = \sum_{n=0}^{N-1} (az^{-1})^n = \frac{1 - (az^{-1})^N}{1 - (az^{-1})} = \frac{1}{z^{(N-1)}} \frac{z^N - a^N}{z - a}$$

Z-transform pairs

Remember about ROC (Region of Convergence):

- causal signal (non-zero only when $n \geq 0$) – outside unit circle
- anticausal signal (non-zero only when $n \leq 0$) – inside unit circle

In the table only causal prototypes are shown.

$$\begin{aligned}\delta(n) & \quad \text{---} \quad 1 \\ u(n) & \quad \text{---} \quad \frac{1}{1-z^{-1}} \\ a^n u(n) & \quad \text{---} \quad \frac{1}{1-az^{-1}} \\ n \cdot a^n u(n) & \quad \text{---} \quad \frac{az^{-1}}{(1-az^{-1})^2}\end{aligned}$$

Inverse \mathcal{Z} - transform

$$x(n) = \frac{1}{2\pi j} \oint_C X(z) z^{n-1} dz$$

- Power series expansion (e.g for finite series) \rightarrow “a series of deltas”
- Partial fraction expansion: $X(z)$ a rational function with M zeros and N distinct poles,

$$X(z) = \sum_{r=0}^{M-N} B_r \cdot z^{-r} + \sum_{k=1}^N \frac{A_k}{1 - d_k z^{-1}}, \quad A_k = (1 - d_k z^{-1}) \cdot X(z) \Big|_{z=d_k}$$

Are we looking for a

- causal (or maybe only right-sided)
- anticausal (... left-sided)
- noncausal (... two-sided?)

solution?

Remark: *these terms are overloaded – understand them as a short for “signal that may be an imp. response of a causal filter” etc.*

$H(z)$ to $h(n)$ (or how to find \mathcal{Z}^{-1})

$$H(z) = \frac{Y(z)}{X(z)} = \frac{\sum_{k=0}^2 b_k z^{-k}}{\sum_{m=0}^2 a_m z^{-m}} = A \frac{\prod_{k=0}^2 (1 - c_k z^{-1})}{\prod_{m=0}^2 (1 - d_m z^{-1})}$$

Zeros at $z = c_k \rightarrow (1 - c_k z^{-1}) = \frac{z - c_k}{z - 0}$ (plus pole at $z = 0$).

Poles at $z = d_m \rightarrow \frac{1}{(1 - d_m z^{-1})} = \frac{z - 0}{z - d_m}$ (plus a zero at $z = 0$).

Knowing poles \rightarrow decompose into a polynomial + partial fractions:

$$\begin{aligned} H(z) &= \sum_{r=0}^{M-N} B_r \cdot z^{-r} && + \sum_{m=1}^N \frac{A_m}{1 - d_m z^{-1}} \\ h(n) &= \sum_{r=0}^{M-N} B_r \cdot \delta(n - r) && + \sum_{m=1}^N A_m u(n) (d_m)^n \end{aligned}$$

So, two conjugate poles (at d_m and d_m^*) give a decaying cosine!

Z-transform of a convolution

$$y[n] = x[n] * h[n] \longrightarrow y(n) = \sum_{k=-\infty}^{+\infty} x(k) \cdot h(n-k)$$

$$Y(z) = \sum_{n=-\infty}^{+\infty} \left[\sum_{k=-\infty}^{+\infty} x(k) \cdot h(n-k) \right] z^{-n} =$$

$$= \sum_{k=-\infty}^{+\infty} \left[x(k) \sum_{n=-\infty}^{+\infty} h(n-k) z^{-n} \right] =$$

(we substitute $m = n - k$ so $n = k - m$)

$$= \sum_{k=-\infty}^{+\infty} \left[x(k) \sum_{m=-\infty}^{+\infty} h(m) z^{-k-m} \right] =$$

$$= \sum_{k=-\infty}^{+\infty} x(k) z^{-k} \sum_{m=-\infty}^{+\infty} h(m) z^{-m}$$

$$Y(z) = X(z) \cdot H(z)$$

And this is the main application of z-transform.

Z-transform and difference equations (1)

$$\sum_{k=0}^N a_k y(n-k) = \sum_{k=0}^M b_k x(n-k)$$

$a_0 = 1$ traditionally

Simpler case of $N = 0$ (FIR, no recursion)

$$\begin{aligned}y(n) &= \sum_{k=0}^M b_k x(n-k) \\Y(z) &= \sum_{k=0}^M b_k \mathcal{Z}[x(n-k)] = \\&= \sum_{k=0}^M b_k X(z) z^{-k} = \\&= X(z) \cdot \sum_{k=0}^M b_k z^{-k} = \\&= X(z) \cdot H(z)\end{aligned}$$

Z-transform and difference equations (2)

Now the general case:

$$\sum_{k=0}^N a_k y(n-k) = \sum_{k=0}^M b_k x(n-k)$$

$$\sum_{k=0}^N a_k Y(z) z^{-k} = \sum_{k=0}^M b_k X(z) z^{-k}$$

$$Y(z) \sum_{k=0}^N a_k z^{-k} = X(z) \sum_{k=0}^M b_k z^{-k}$$

$$Y(z) = X(z) \cdot \frac{\sum_{k=0}^M b_k z^{-k}}{\sum_{k=0}^N a_k z^{-k}}$$

Recall that the transform is linear, and shift is represented by $z - k$ operator.

System and its difference equation

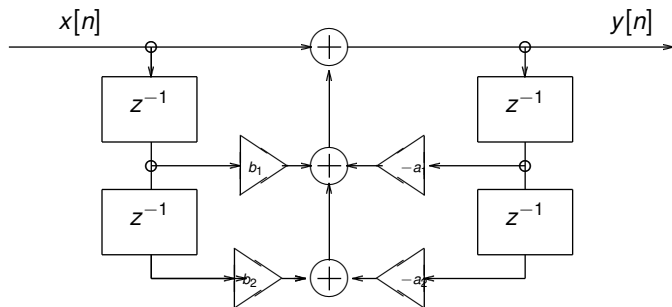

$$y(n) = x(n) + b_1x(n-1) + b_2x(n-2) - a_1y(n-1) - a_2y(n-2)$$

$$y(n) + a_1y(n-1) + a_2y(n-2) = x(n) + b_1x(n-1) + b_2x(n-2)$$

$$\sum_{m=0}^2 a_m y(n-m) = \sum_{k=0}^2 b_k x(n-k)$$

Difference equation and $H(z)$

z^{-1} - shift operator

$$\sum_{m=0}^2 a_m y(n-m) = \sum_{k=0}^2 b_k x(n-k)$$

$$\sum_{m=0}^2 a_m Y(z) z^{-m} = \sum_{k=0}^2 b_k X(z) z^{-k}$$

$$Y(z) \sum_{m=0}^2 a_m z^{-m} = X(z) \sum_{k=0}^2 b_k z^{-k}$$

$$H(z) = \frac{Y(z)}{X(z)} = \frac{\sum_{k=0}^2 b_k z^{-k}}{\sum_{m=0}^2 a_m z^{-m}}$$

System and its $H(z)$

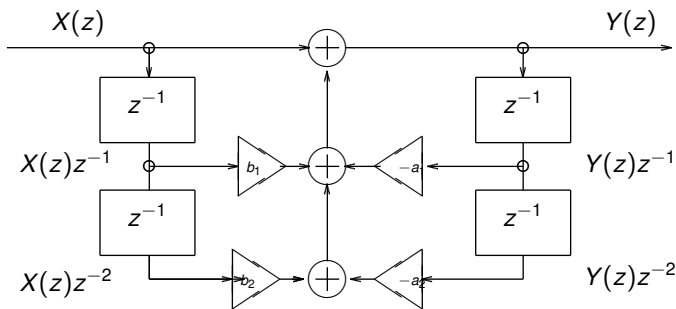

$$Y(z) = X(z) + b_1 X(z)z^{-1} + b_2 X(z)z^{-2} - a_1 Y(z)z^{-1} - a_2 Y(z)z^{-2}$$

$$Y(z) + a_1 Y(z)z^{-1} + a_2 Y(z)z^{-2} = X(z) + b_1 X(z)z^{-1} + b_2 X(z)z^{-2}$$

$$\sum_{m=0}^2 a_m Y(z)z^{-m} = \sum_{k=0}^2 b_k X(z)z^{-k}$$

$$H(z) = \frac{Y(z)}{X(z)} = \frac{\sum_{k=0}^2 b_k z^{-k}}{\sum_{m=0}^2 a_m z^{-m}}$$

System defined by $H(z)$ + complex sinusoid

$$x(n) = e^{jn\theta} \longrightarrow \boxed{h(n)} \longrightarrow y(n) = ?$$

$$\begin{aligned} y(n) &= \sum_k h(k) \cdot e^{j(n-k)\theta} = \\ &= \sum_k h(k) \cdot e^{j(-k)\theta} \cdot e^{jn\theta} = \\ &= e^{jn\theta} \sum_k h(k) \cdot e^{j(-k)\theta} = \\ &= e^{jn\theta} H(e^{j\theta}) \\ H(e^{j\theta}) &= A(\theta)e^{j\phi(\theta)} \end{aligned}$$

$A(\theta)$ - magnitude, $\phi(\theta)$ - phase of $H(e^{j\theta})$

If $x(n)$ is periodic - we can decompose it into harmonics (linearity).

As you can see, when we deal with periodic signals, we use $H(e^{j\theta}) = H(z)|_{z=e^{j\theta}}$

System defined by $H(z)$ + sine/cosine signal

We say $H(z)$ meaning “transfer function”, but we immediately substitute $z = e^{j\theta}$

$$x(n) = e^{jn\theta} \longrightarrow \boxed{h(n)} \longrightarrow y(n) = e^{jn\theta} H(e^{j\theta})$$

so if $x(n) = \cos(n\theta) = 1/2 \cdot (e^{jn\theta} + e^{-jn\theta})$
then $y(n) = 1/2 \cdot (\cdot H(e^{j\theta})e^{jn\theta} + \cdot H(e^{-j\theta})e^{-jn\theta})$

$$H(e^{j\theta}) = A(\theta)e^{j\phi(\theta)}$$

and $y(n) = A(\theta) \cdot 1/2 \cdot (e^{jn\theta} + e^{-jn\theta}) \cdot e^{j\phi(\theta)}$
(for a real $h(n)$ $\phi(\theta)$ is odd: $\phi(-\theta) = -\phi(\theta)$)
and $y(n) = A(\theta) \cdot 1/2 \cdot (e^{j(n\theta+\phi(\theta))} + e^{-j(n\theta+\phi(\theta))})$

$$y(n) = A(\theta) \cdot \cos(n\theta + \phi(\theta))$$

Repeat the same with $\sin()$ \longrightarrow at home.

E.g. $x(n) = 3 + 5\sin(0.1\pi n)$ \longrightarrow a DC component and a 0.1π sinusoidal signal. So
 $y(n) = A(0) \cdot 3 + A(0.1\pi) \cdot 5\sin(0.1\pi n + \phi(0.1\pi))$.

Note: Z-transform is **NOT** a good tool to calculate this!!