

DVB[®]

**Digital Video
Broadcasting**

History

- 1994 – DVB-C(able) and DVB-S(atellite)
- 1997 – DVB-T (errestrial) (EU standard)
- 1998 - The first commercial DVB-T (UK, Digital Terrestrial Group)
- 2003 - Berlin, the first area to stop broadcasting analog TV signals.
- 2010 - many european countries to be fully covered with DTV and switch off ATV.

Technology (DVB-T)

- MPEG-2 or MPEG-4 part 10 (H.264)
- Energy dispersal
- Interleaving + correction codes
- Modulation (QPSK, 16- or 64-QAM)
- OFDM with pilots (2k, 4k, 8k subchannels)
- Guard interval ($\frac{1}{4}$ - .. - $\frac{1}{32}$)
- effect: 5 – 32 Mbit/s
- Carrier: UHF/VHF

DVB-T transmitter

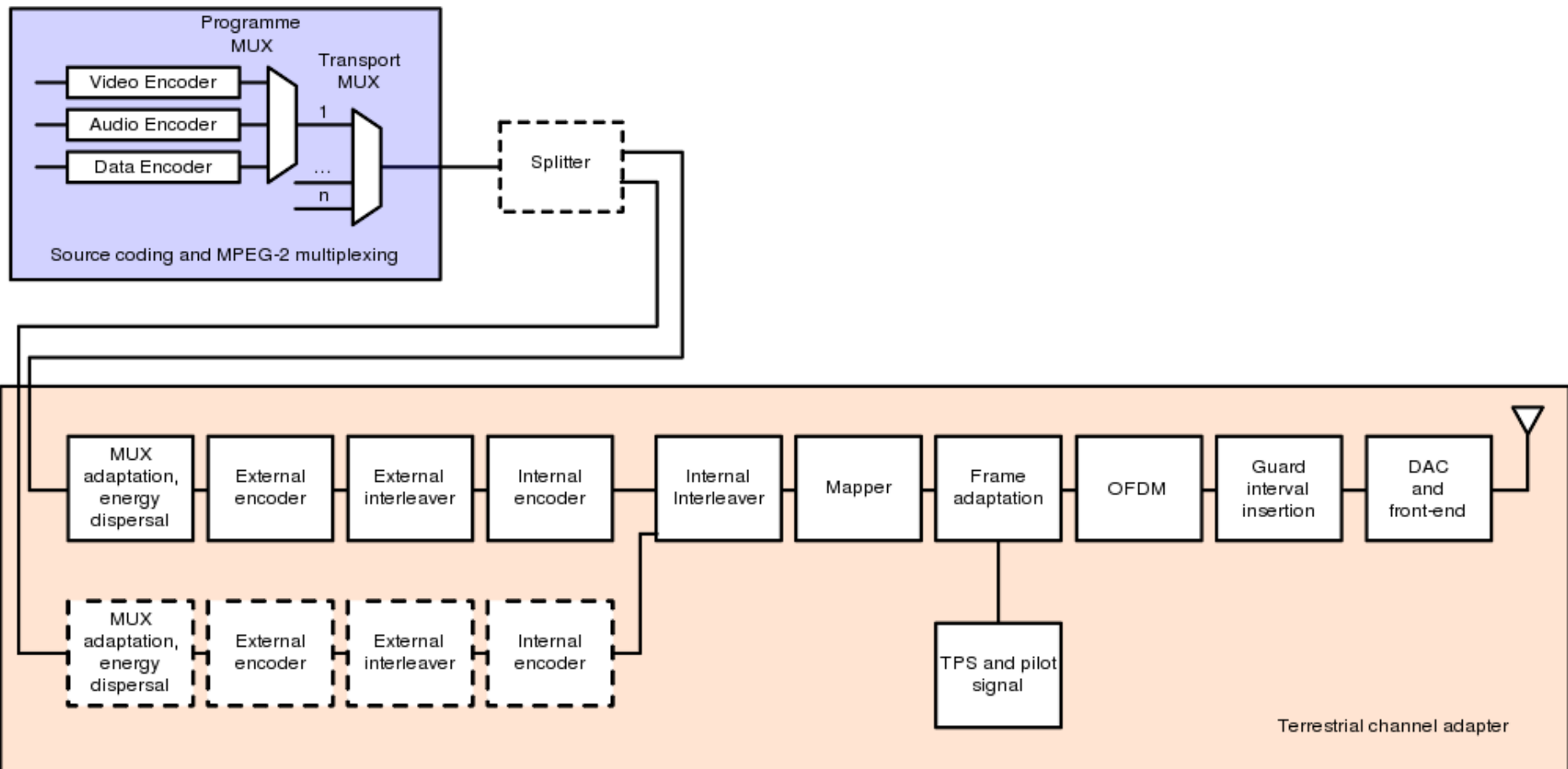

Disperser & interleaver

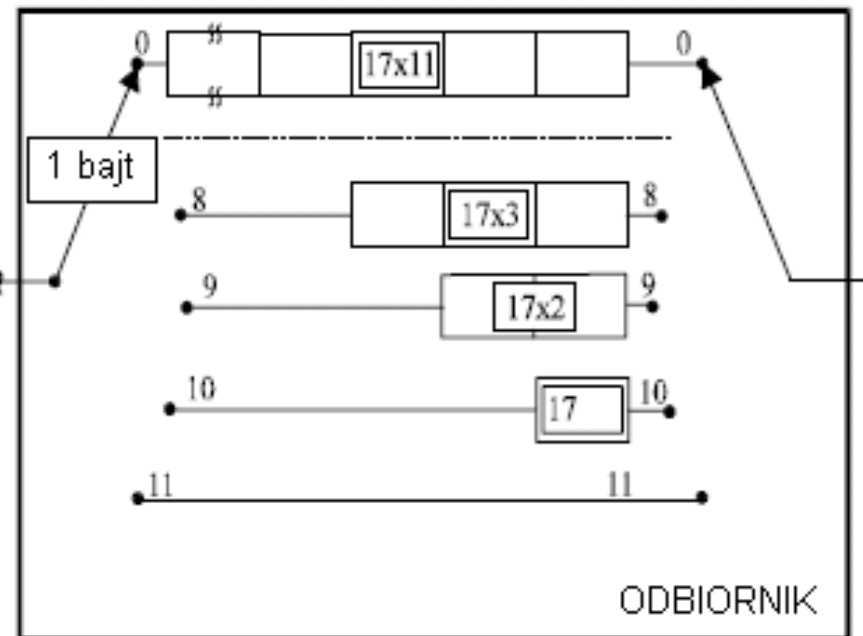
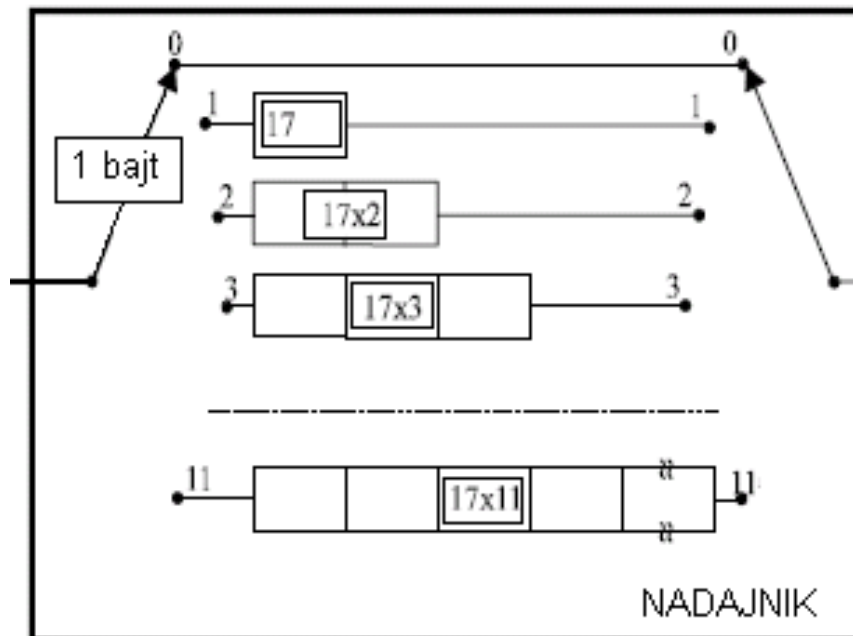
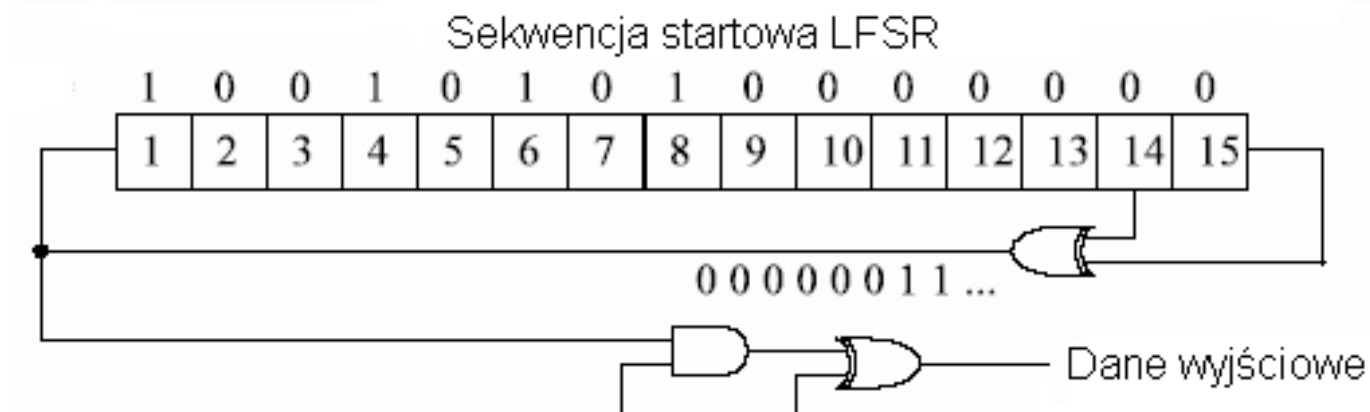

Mapper: 16-QAM

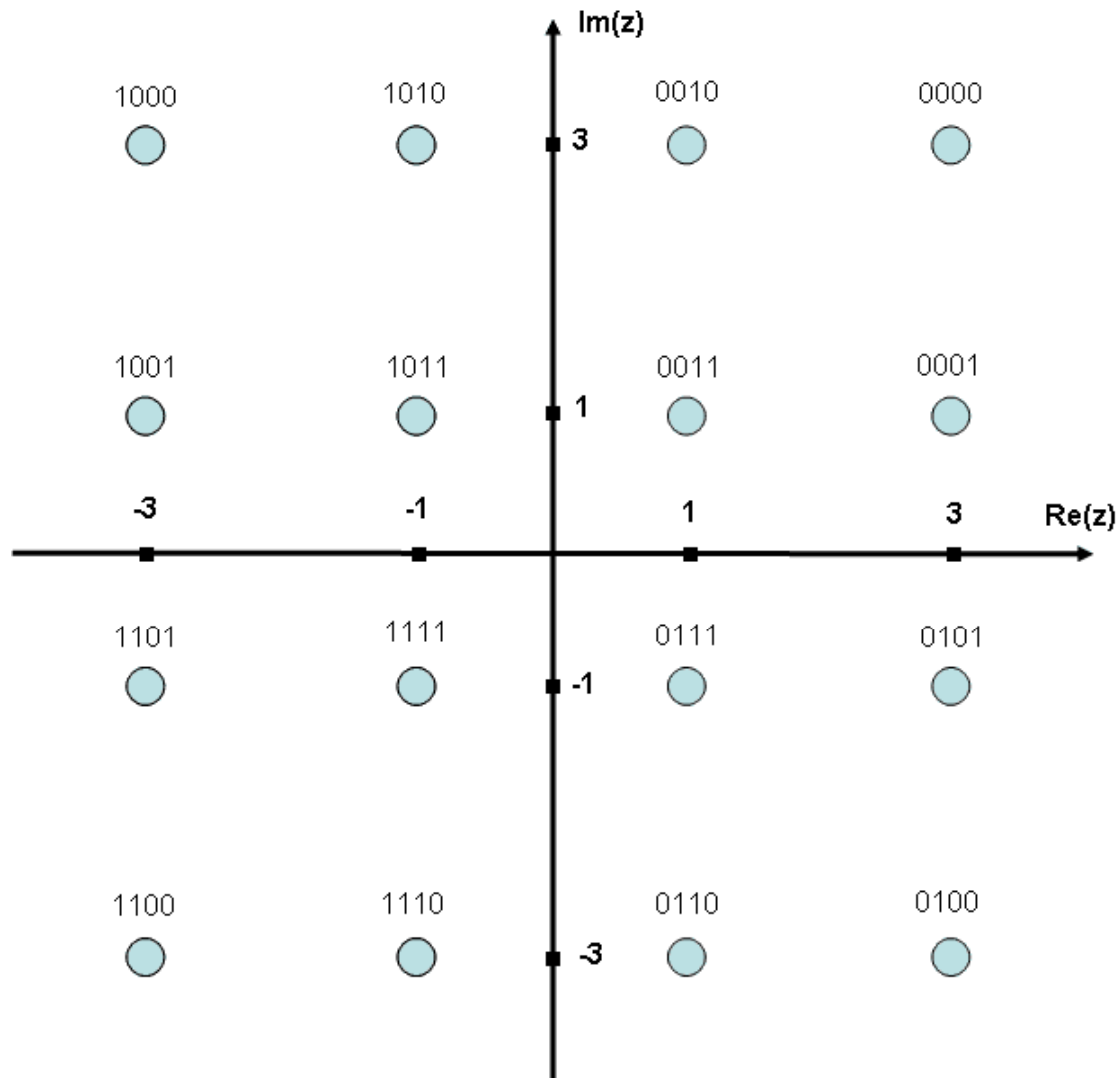

OFDM with pilots

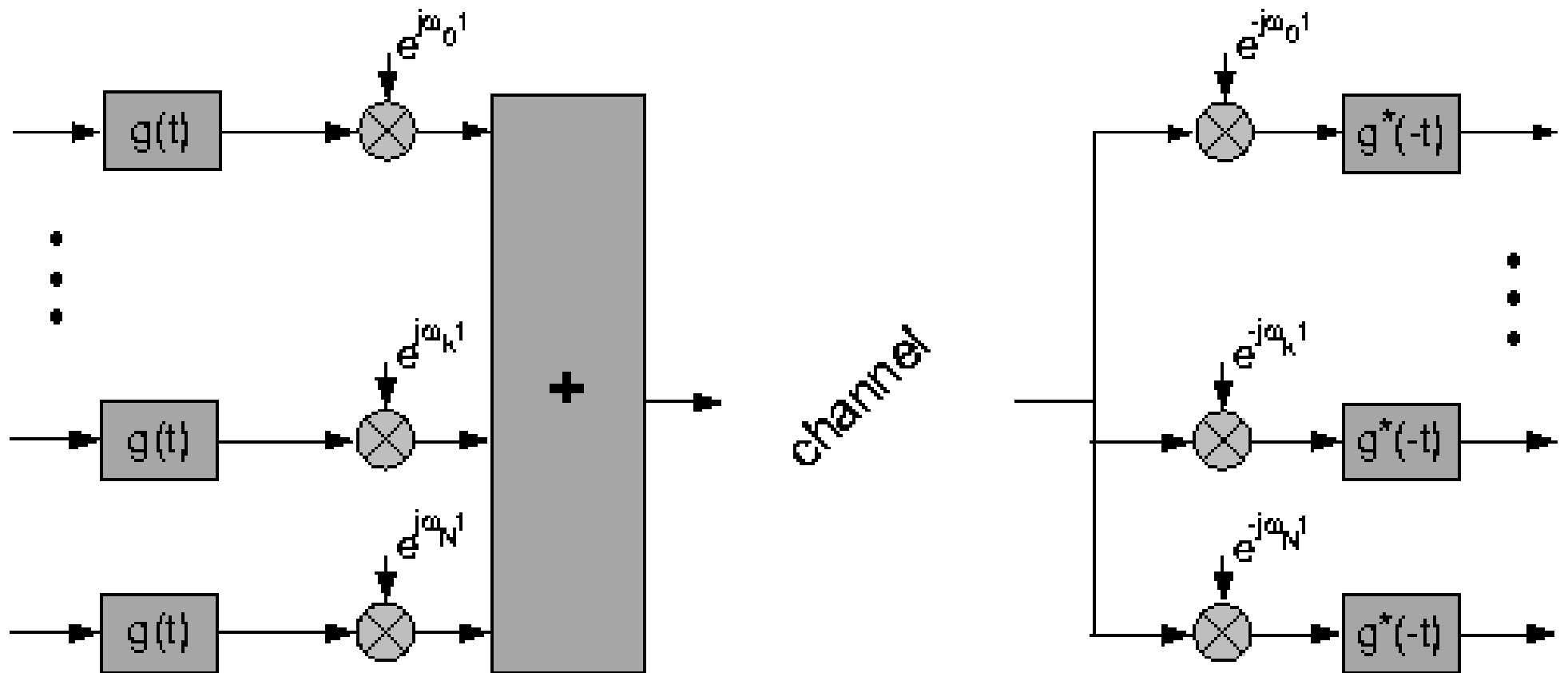

Guard interval

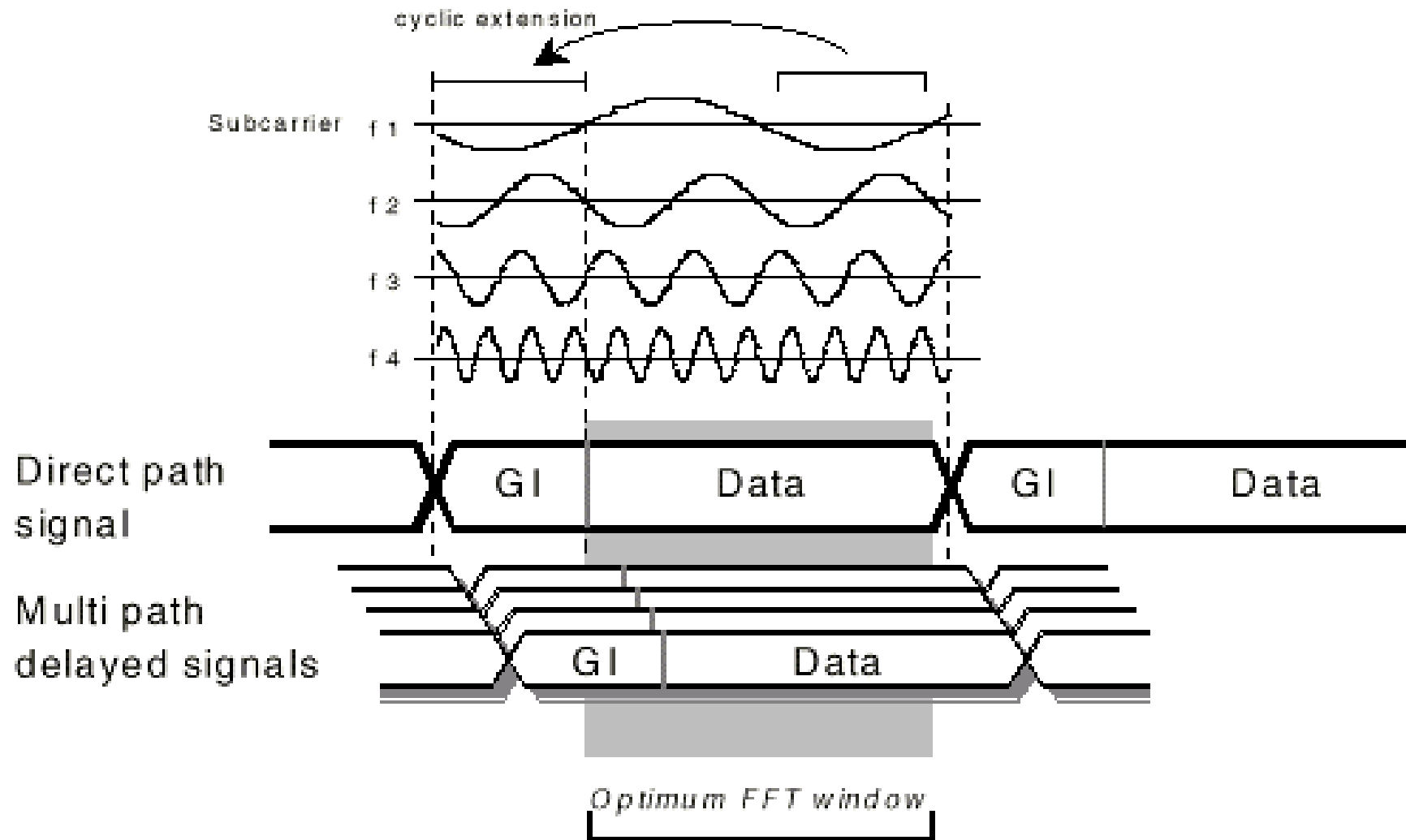

Channel estimation

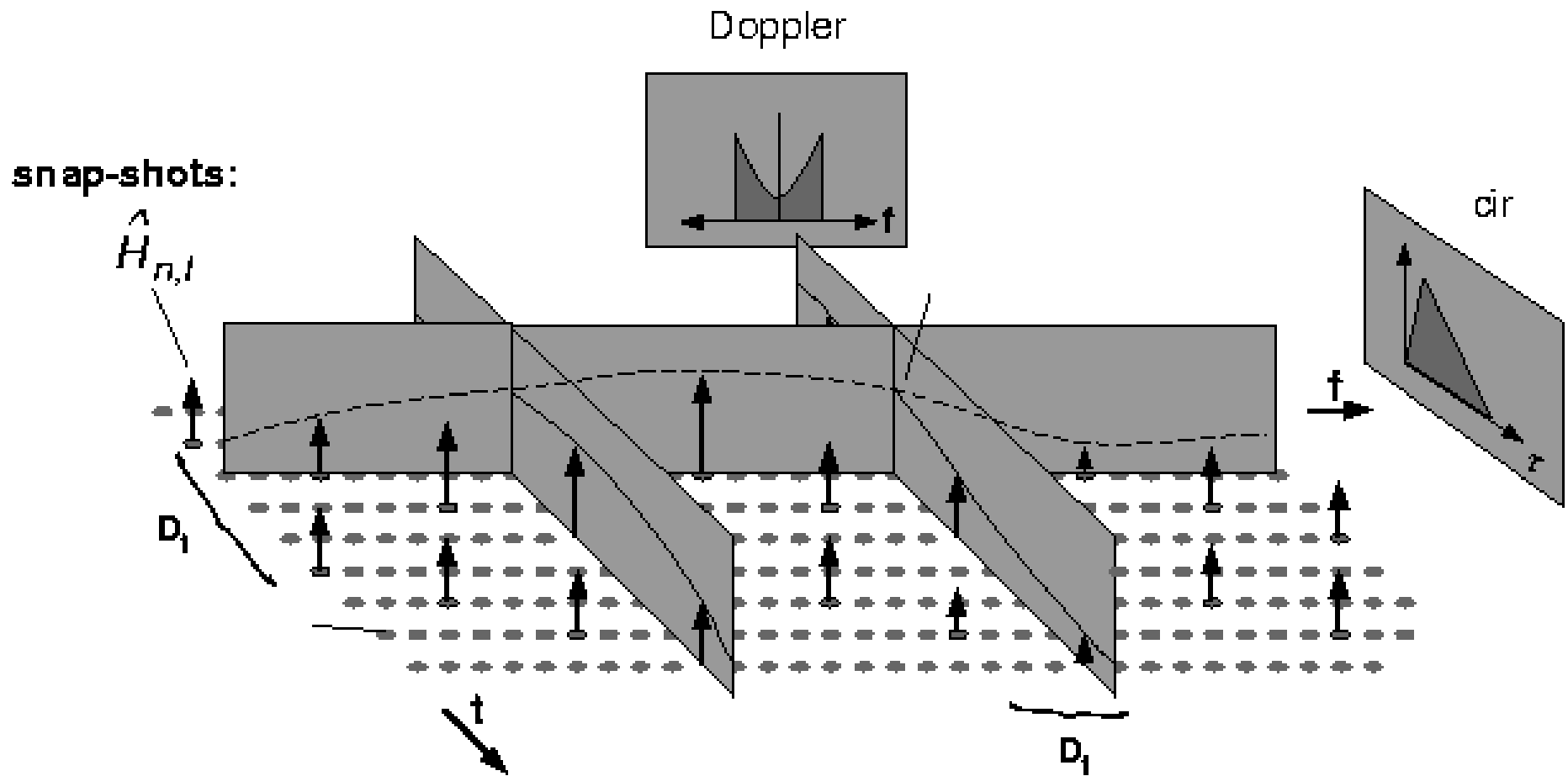

Front end

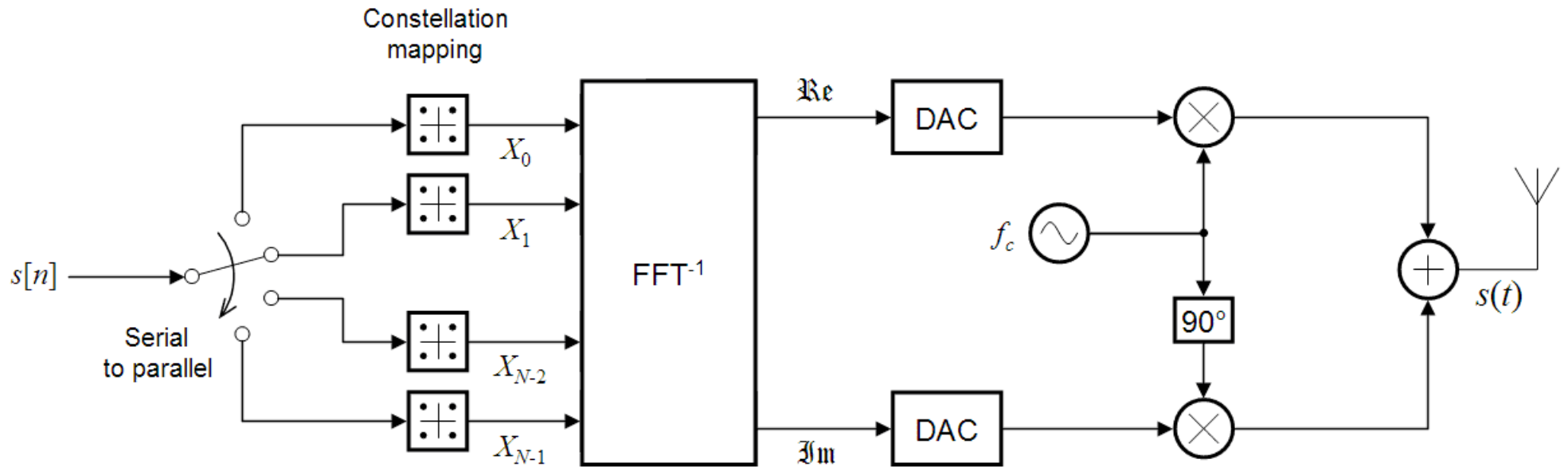

Receiver

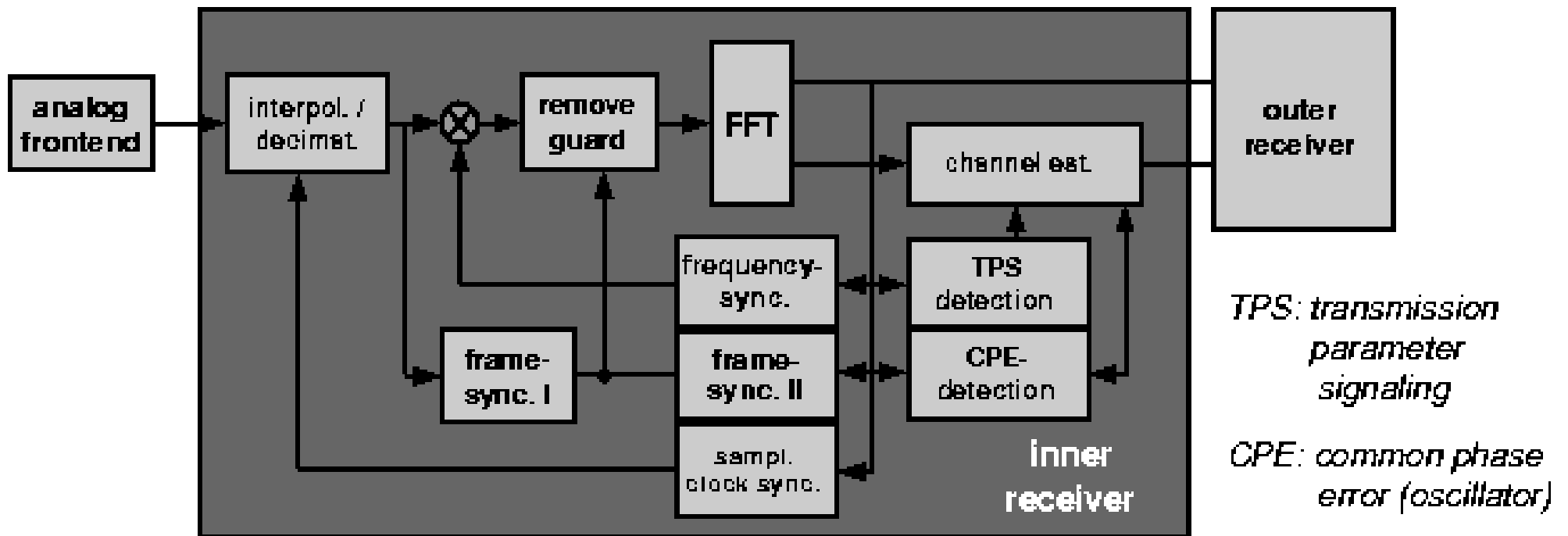

Problem: PAPR

```
k=ones(1,1024);  
plot(max(-10,20*log10(abs(fft(k,4096))))))  
hold on  
k1=k.*exp(2*pi*j*rand(1,1024));  
plot(max(-10,20*log10(abs(fft(k1,4096))))))
```

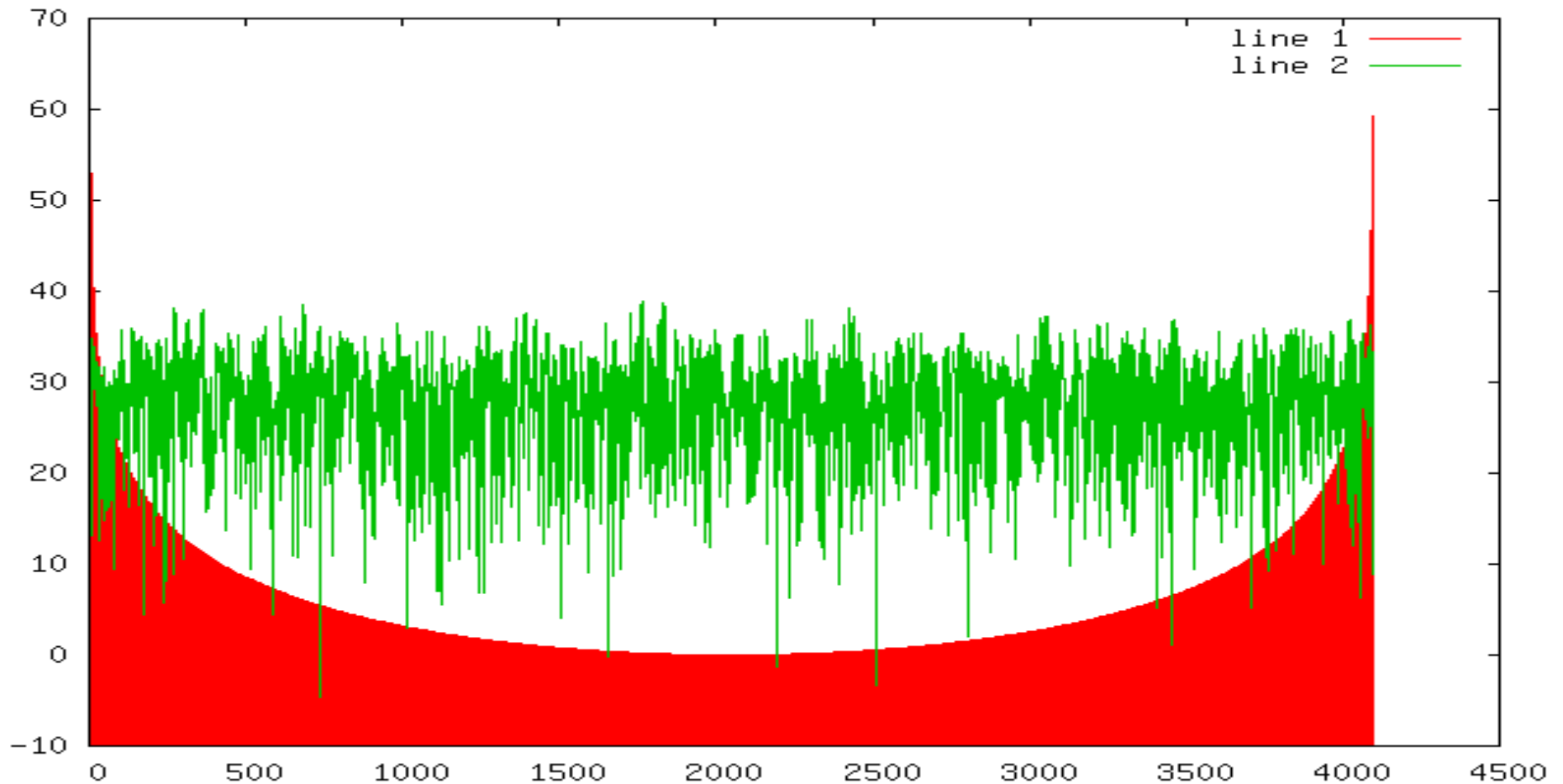

PAPR fight

- Clipping and filtering
- Selective mapping (optimize spread before OFDM)
- Partial transmit sequence (optimize subcarriers after OFDM)
- Nonlinear coding (manipulate transmitted sequence so that peaks are avoided)